

foil

USER'S GUIDE

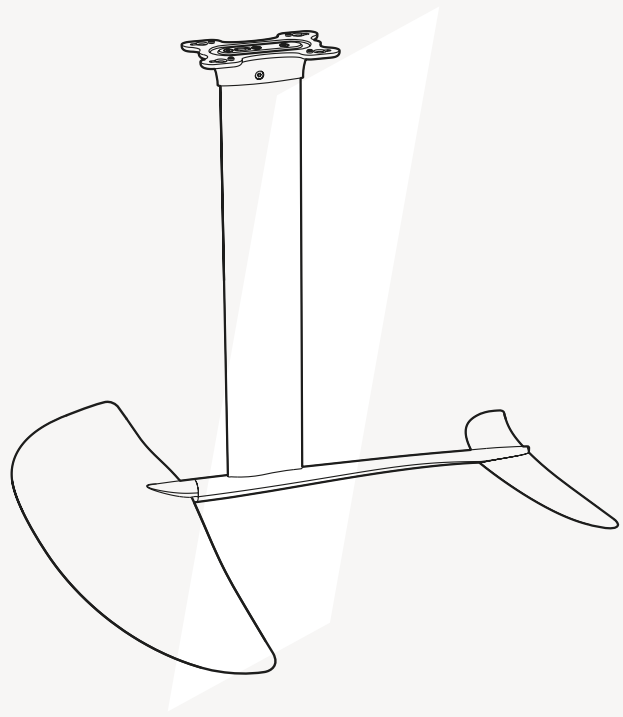

takuma
fly above water

Thank you for choosing the **TAKUMA FOIL**

Make sure you are able to use this product in a safe and responsible manner. Do not use it if you are not in good physical health, if you are not an experienced swimmer, or if you are under the influence of alcohol, drugs or medications.

The use of a foil exposes you and others around you to serious risks, the wings and mast have sharp edges that could cause serious bodily harm, even death. It is recommended to take lessons by a certified instructor before using this product on your own.

Always make sure you are using this product at a safe distance from others and away from any obstacles. Check for any legal requirements and rules that may apply in your location. Observe local weather forecasts and never go out in dangerous conditions. Take care when handling the foil and always store it in its protective carrying case.

The following are required when using your **FOIL**:

- **a certified personal flotation device (PFD)**
- **a certified helmet**
- **a full neoprene wetsuit, booties and gloves**

By using this product, you agree that you do so at your own risk. TAKUMA does not accept any responsibility for personal injury or material damage in the case of an accident due to incorrect use.



Assembly video tutorials

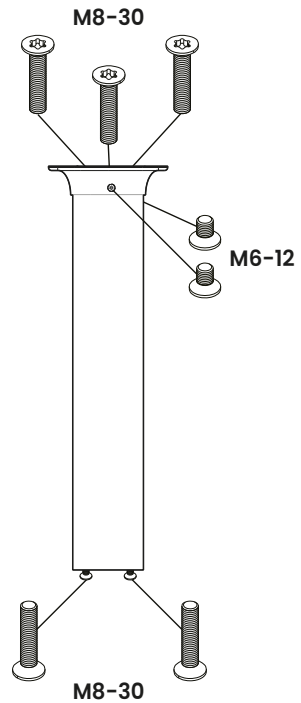
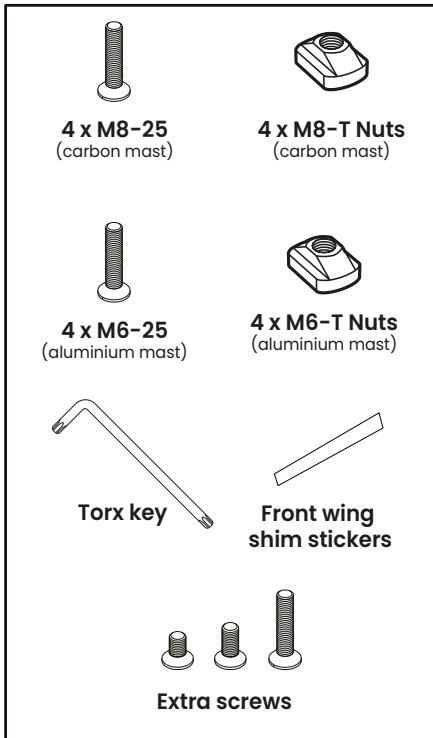
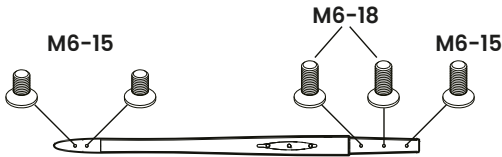
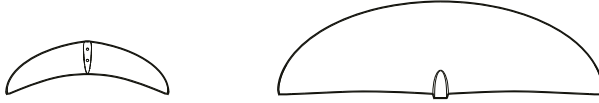

Apply a thin layer of **anti-corrosion gel** on all screws before use to avoid corrosion.

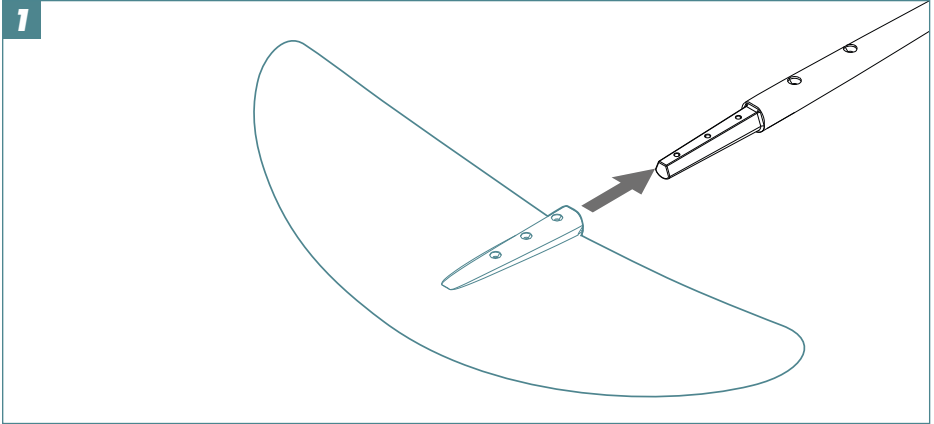

If the front wing seems slightly loose you can attach a front wing shim sticker to the sides of the fuselage.

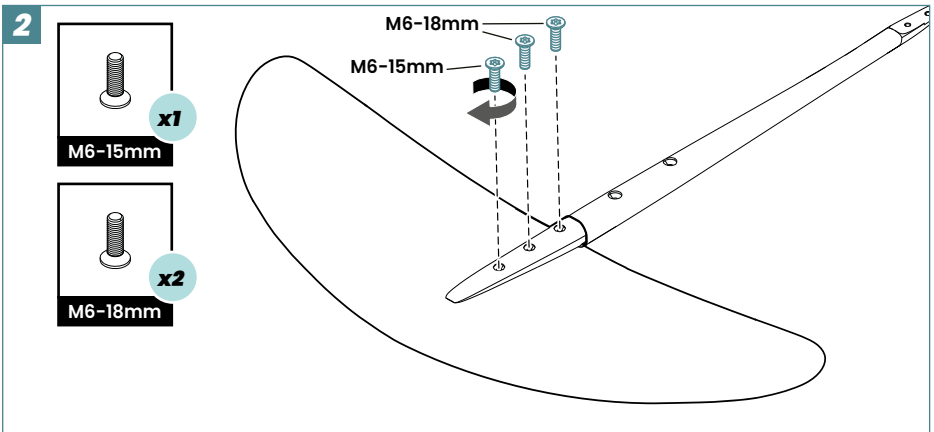
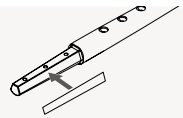

3

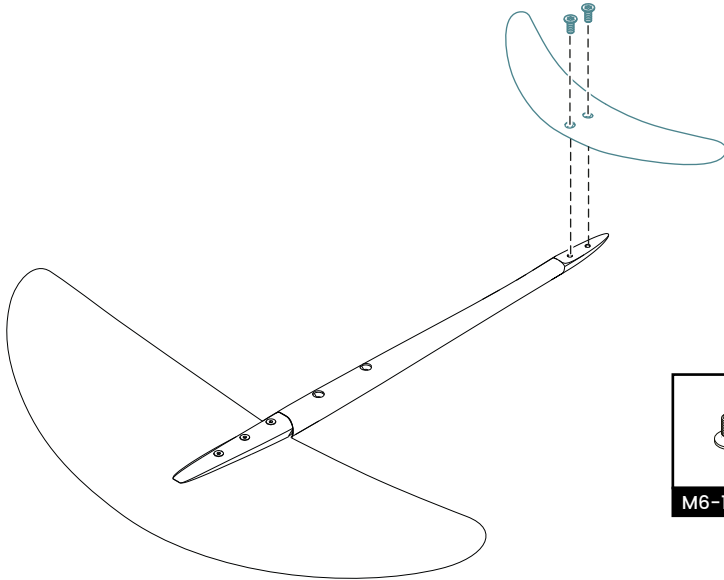

4

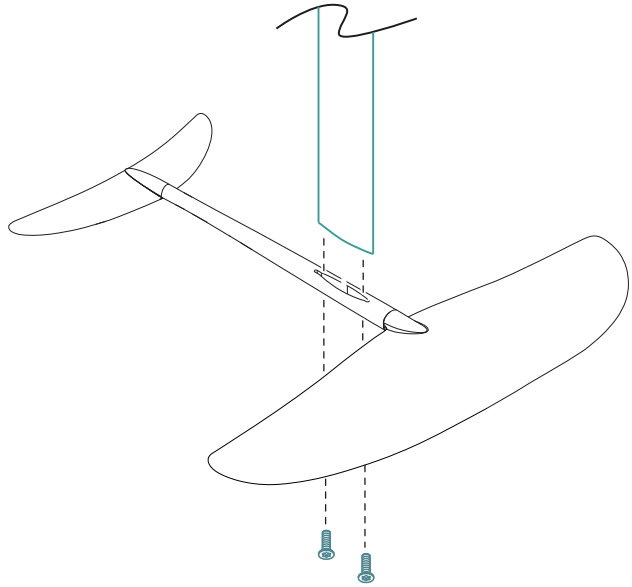
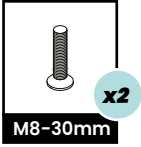

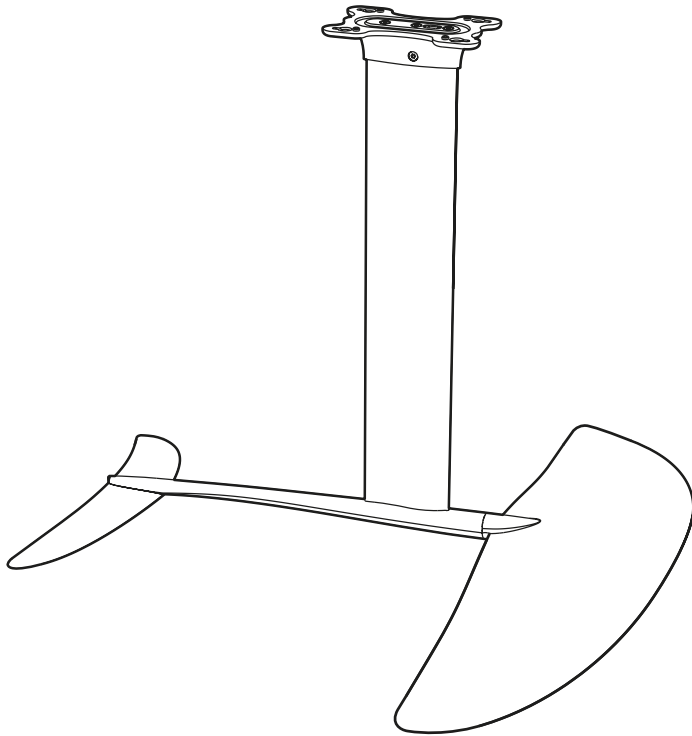

CARBON MAST

Foil mount

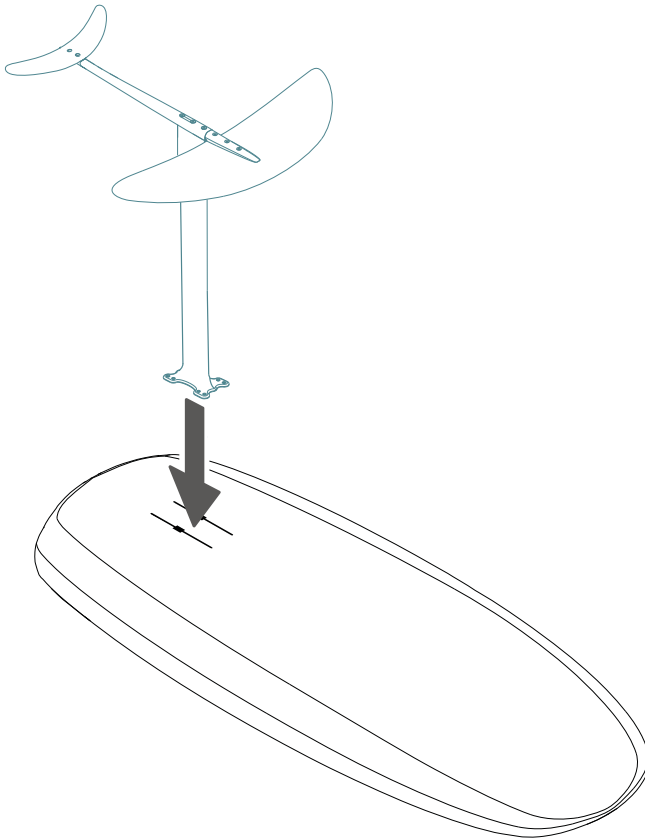

1

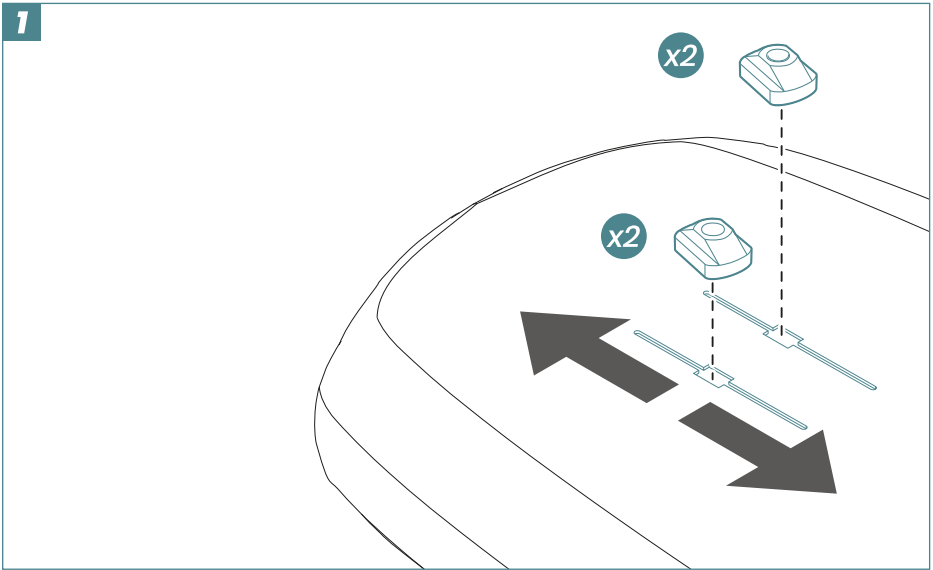

2

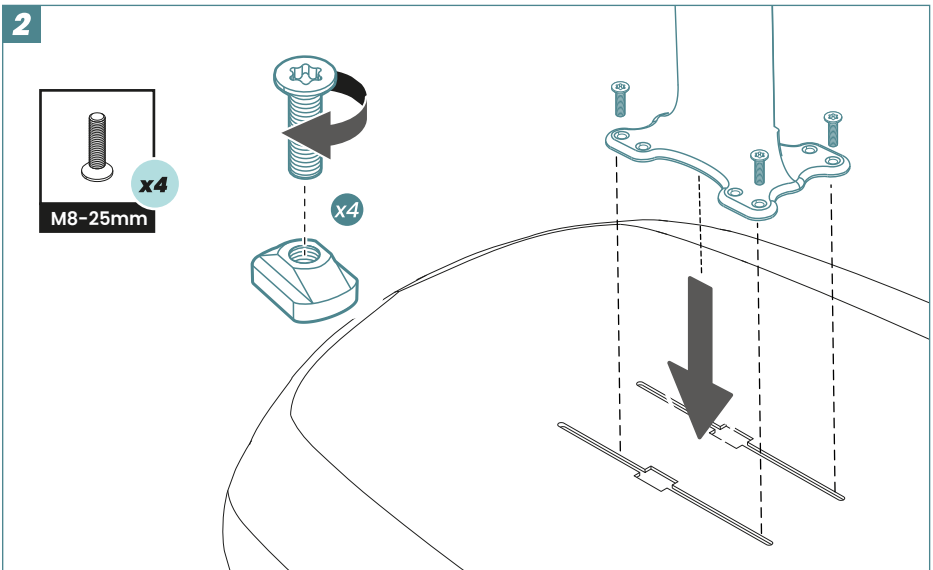

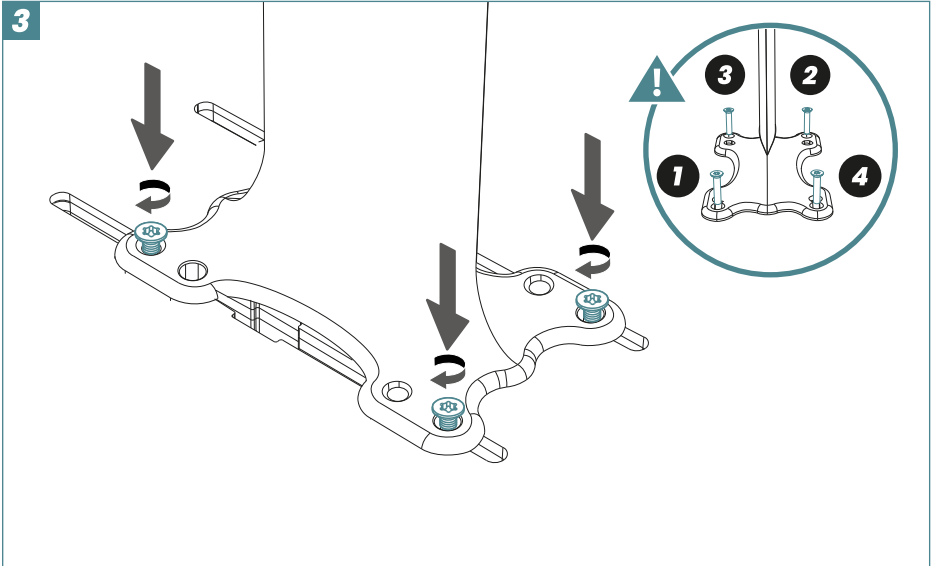

ALUMINUM MAST

Foil mount

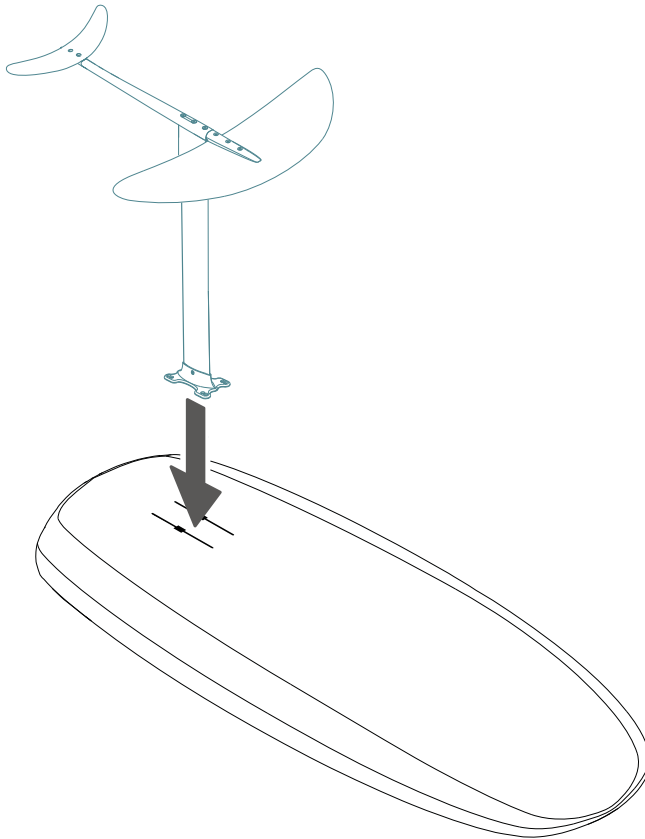

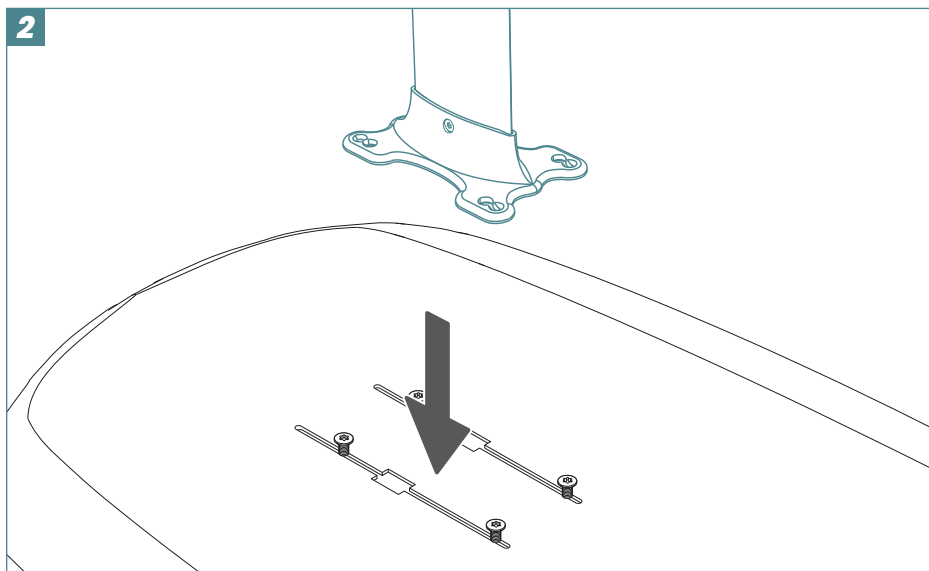
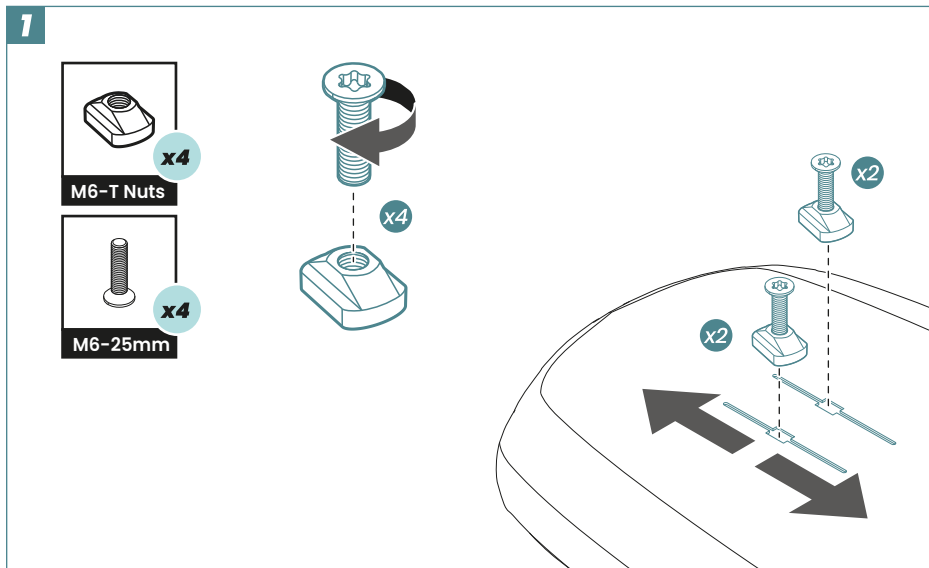

3

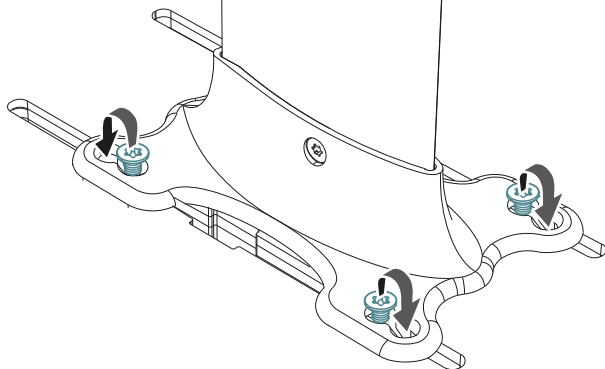

4

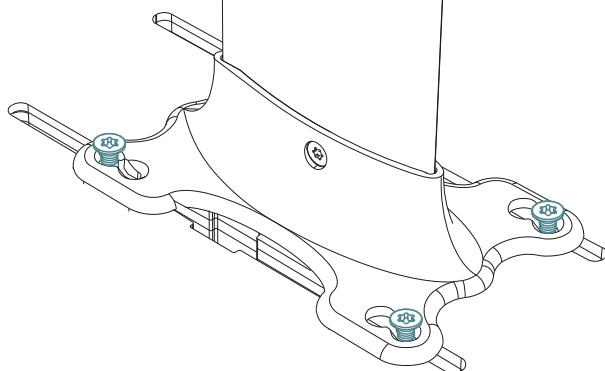

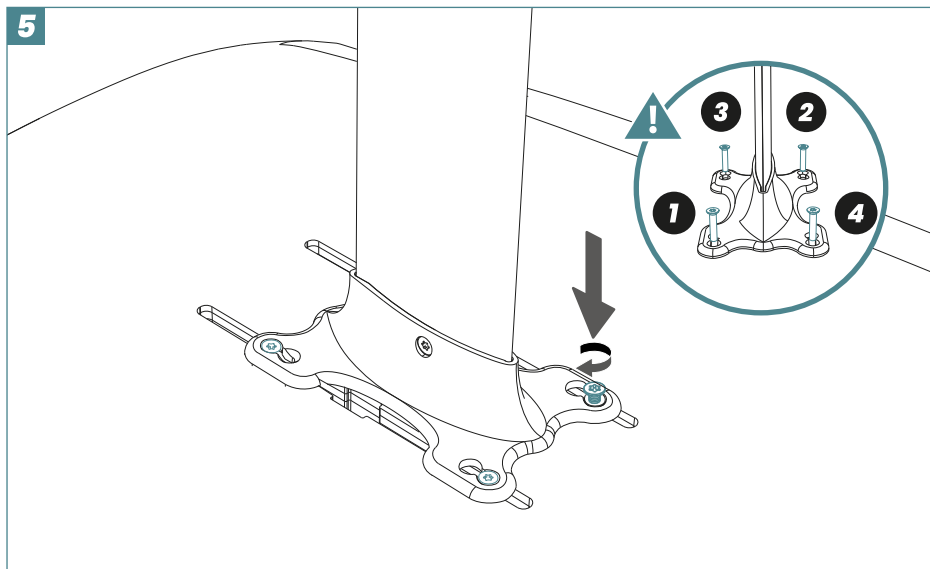

Foil removal

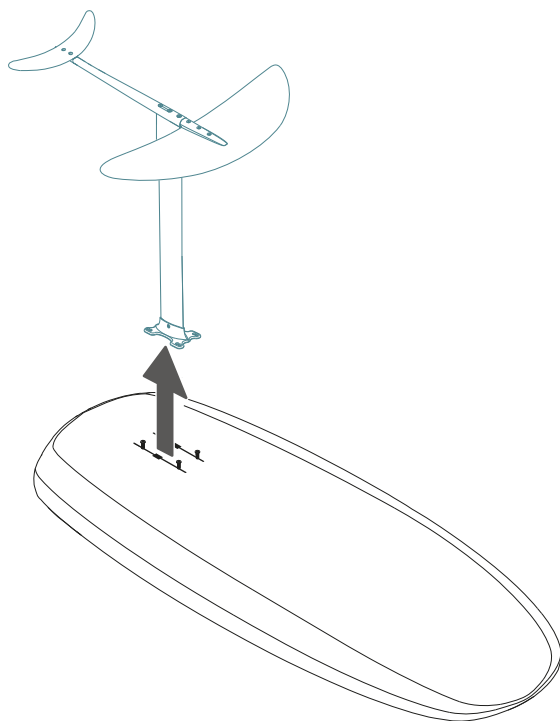

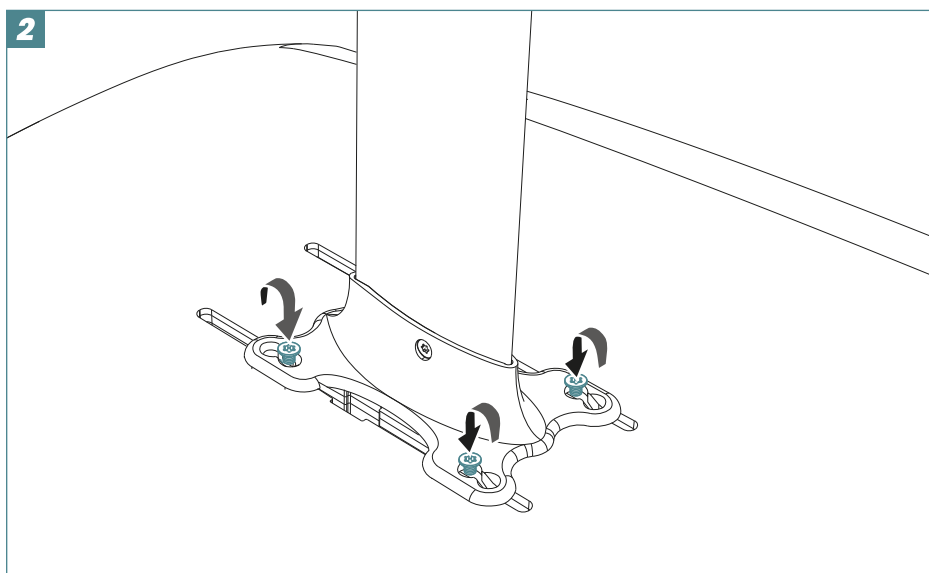
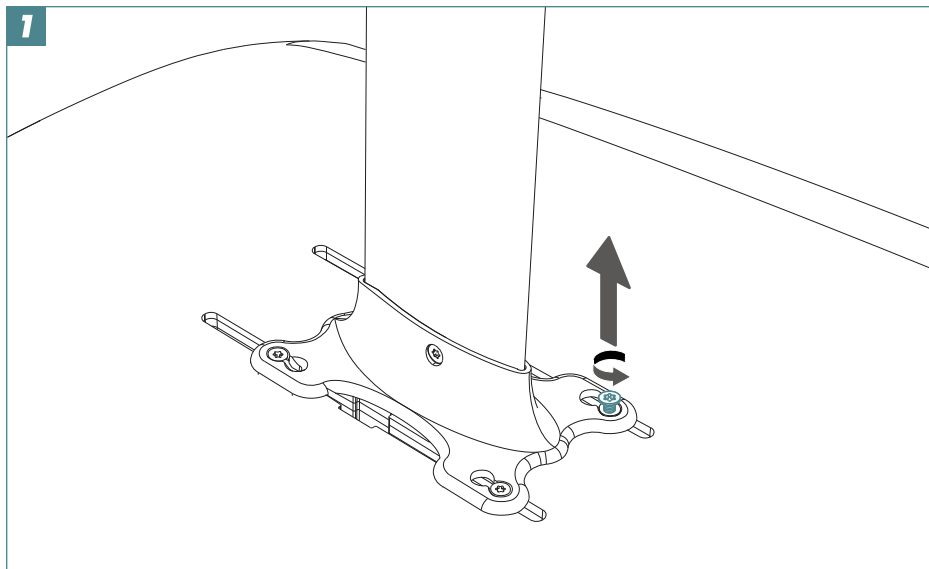

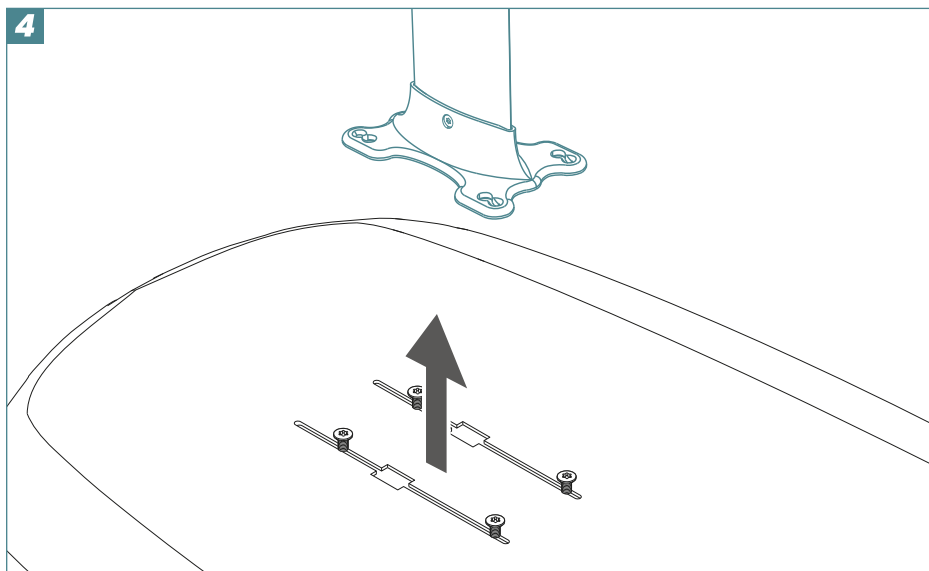
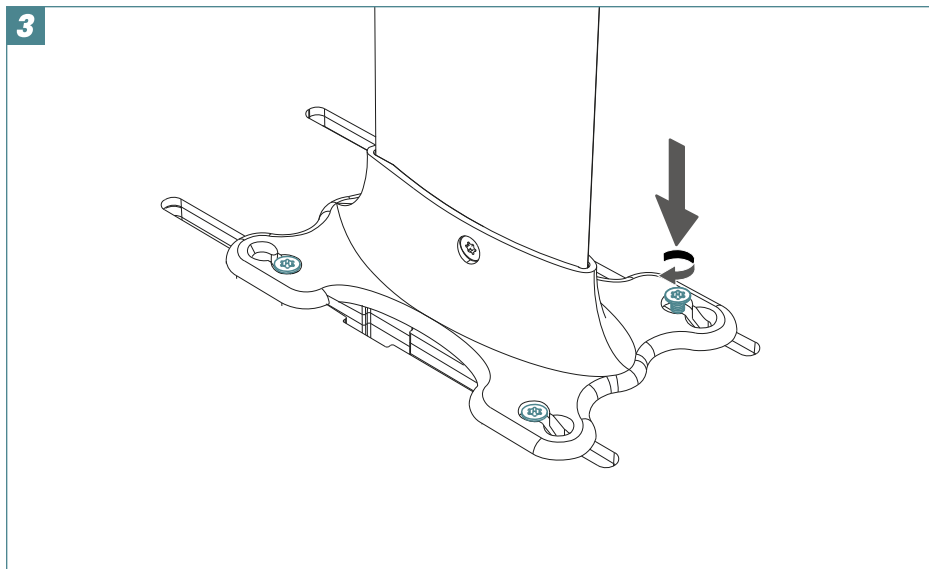

Innovative Top Plate Design (Aluminum mast)

For quick and easy installation, allowing you to maintain the same position each time you reattach the foil.

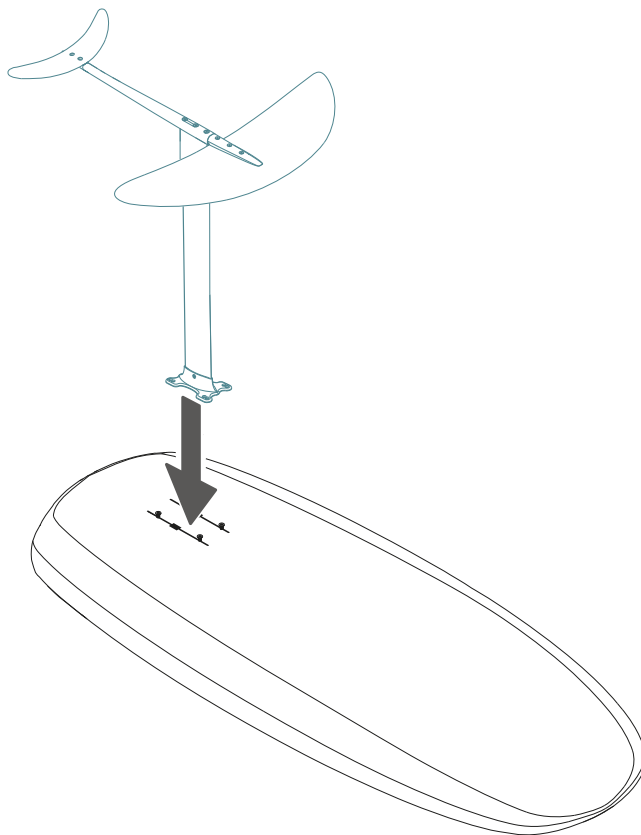

1

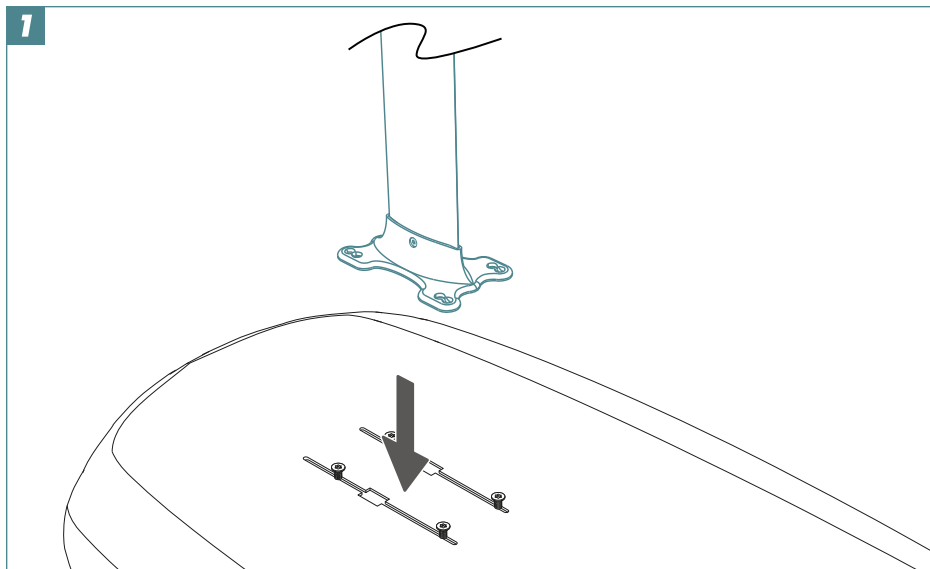

2

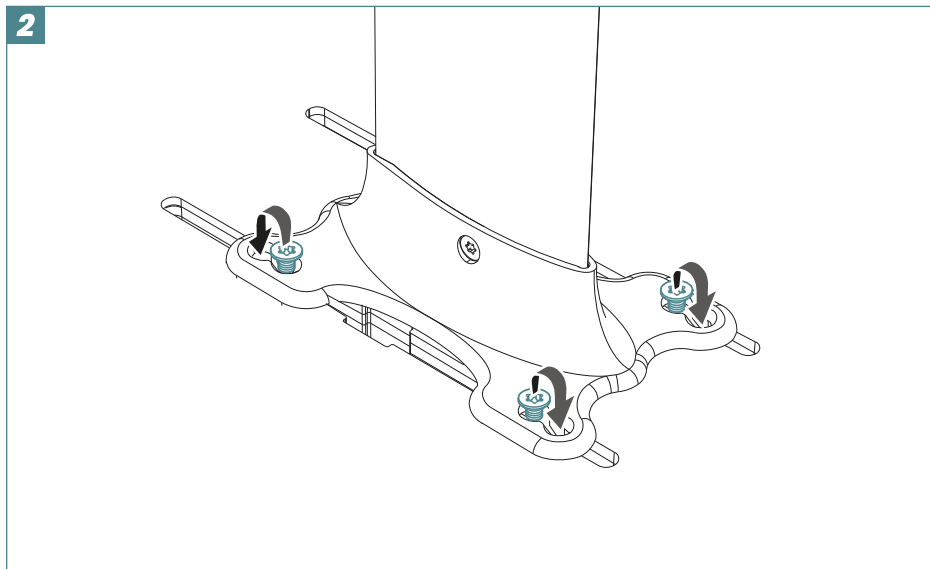

3

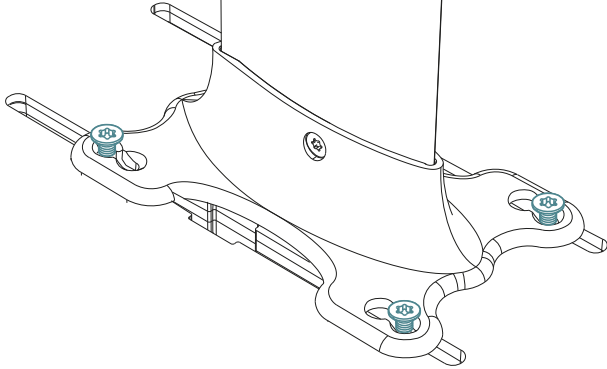

4

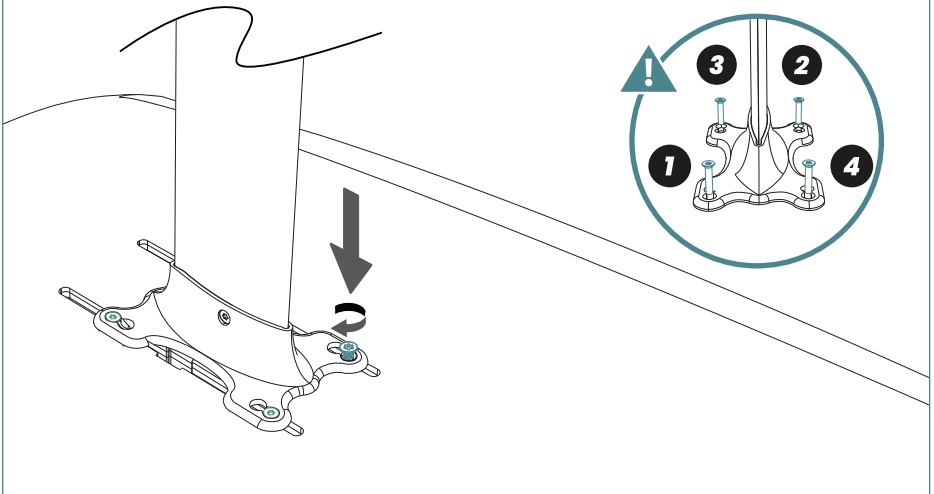

Optimum position

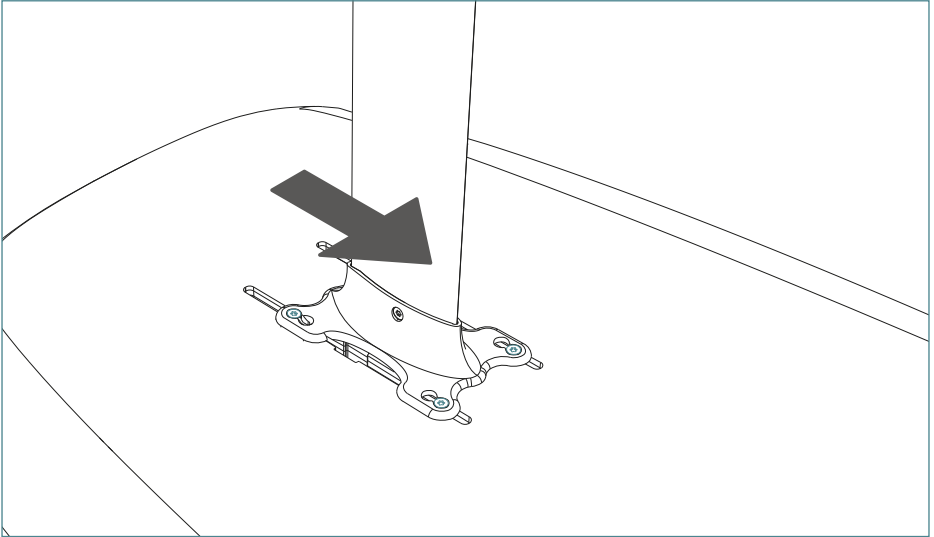

If there is too much lift

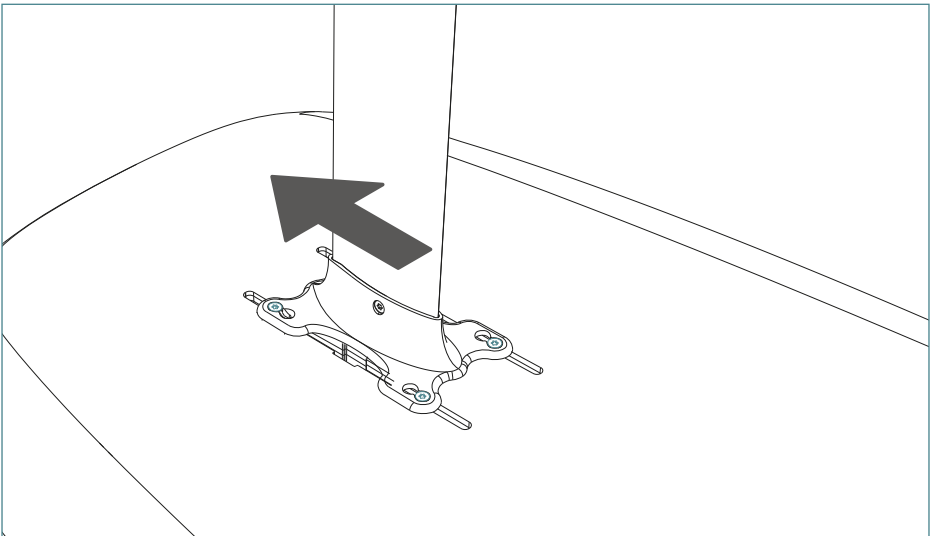



Please refer to our website to review our warranty policy:
[takuma.com](https://www.takuma.com)



takuma

fly above water

After-Sales Service:
customerservices@takuma.com

Please find our tutorial videos on our youtube channel:
<http://youtube.takuma.com>

